

# WSxxxP4SMA(-B) Series

## Transient Voltage Suppressor

### Features

- 400 watts Peak Pulse Power (10/1000  $\mu$ s)
- Unidirectional and Bidirectional Protection
- Fast Response Time : Typically < 1ps
- Excellent Clamping Capability
- Glass Passivated Junction
- Built-in Strain relief
- Low inductance
- Low profile package
- High temperature solder:260 $^{\circ}$ C/20 seconds at terminal

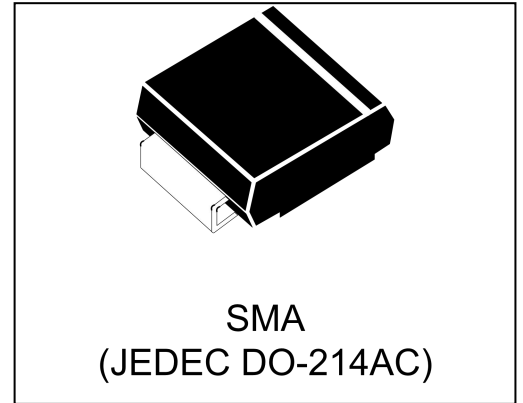

### Mechanical Characteristics

- JEDEC DO-214AC(SMAJ) package
- Molding compound flammability rating: UL 94V-0
- Marking: Marking Code
- Packaging: Tape and Reel per EIA 481
- RoHS/WEEE Compliant

### Applications

- I/O Interfaces
- Power lines
- Automotive and Telecommunication
- Computers & Consumer Electronics
- Industrial Electronics

Absolute Maximum Rating			
Rating	Symbol	Value	Units
Peak Pulse Power ( $t_p = 10/1000\mu$ s) (see Note1,2& 3)	$P_{PPM}$	400	Watts
Peak pulse current (10/1000 $\mu$ s) (see Note2&3)	$I_{PPM}$	See Electrical Characteristics	A
Peak Forward surge current (see Note4&5)	$I_{FSM}$	40	A
Power Dissipation on infinite heat sink $T_A = 50^{\circ}$ C (Fig5)	$P_D$	1.0	W
Operating Junction Temperature range	$T_J$	-65 to + 150	$^{\circ}$ C
Storage Temperature range	$T_{STG}$	-65 to + 150	$^{\circ}$ C

**Note1:** Peak Pulse Power Rating as Pulse Width ,per Fig1.

**Note2:** Peak Pusle Power or Current Derated above  $T_A=25^{\circ}$ C Per Fig. 2 and Non-Repetitive Current Pulse,Per Fig.3.

**Note3:** Mounted on 5.0x5.0mm<sup>2</sup> copper pad to each terminal.

**Note4:** 8.3ms Single Half Sine Wave or Equivalent Square Wave

**Note5:** Maximum Forward Surge Current only for Unidirectional Device per Fig6.

## Electrical Characteristics

Part Number		Reverse Stand off Voltage $V_{RWM}$ (Volts)	Breakdown Voltage $V_{BR}(\text{Volts})@I_T$		Test Current $I_T$ (mA)	Maximum Clamping Voltage $V_C@I_{PP}$ (Volts)	Maximum Peak Pulse Current $I_{PP}$ (Amps)	Maximum Reverse Leakage $I_R@V_{RWM}$ ( $\mu$ A)
			MIN	MAX				
UNI-POLAR	BI-POLAR							
WS5.0P4SMA	WS5.0P4SMA-B	5.0	6.40	7.07	10	9.2	43.5	800
WS6.0P4SMA	WS6.0P4SMA-B	6.0	6.67	7.37	10	10.3	38.8	800
WS6.5P4SMA	WS6.5P4SMA-B	6.5	7.22	7.98	10	11.2	35.7	500
WS7.0P4SMA	WS7.0P4SMA-B	7.5	7.78	8.60	10	12.0	33.3	200
WS7.5P4SMA	WS7.5P4SMA-B	7.5	8.33	9.21	1	12.9	31.0	100
WS8.0P4SMA	WS8.0P4SMA-B	8.0	8.89	9.83	1	13.6	29.4	50
WS8.5P4SMA	WS8.5P4SMA-B	8.5	9.44	10.40	1	14.4	27.8	20
WS9.0P4SMA	WS9.0P4SMA-B	9.0	10.00	11.10	1	15.4	26.0	10
WS10P4SMA	WS10P4SMA-B	10	11.10	12.30	1	17.0	23.5	5
WS11P4SMA	WS11P4SMA-B	11	12.20	13.50	1	18.2	22.0	5
WS12P4SMA	WS12P4SMA-B	12	13.30	14.7	1	19.9	20.1	5
WS13P4SMA	WS13P4SMA-B	13	14.40	15.90	1	21.5	18.6	1
WS14P4SMA	WS14P4SMA-B	14	15.60	17.20	1	23.2	17.2	1
WS15P4SMA	WS15P4SMA-B	15	16.70	18.50	1	24.4	16.4	1
WS16P4SMA	WS16P4SMA-B	16	17.80	19.70	1	26.0	15.4	1
WS17P4SMA	WS17P4SMA-B	17	18.90	20.90	1	27.6	14.5	1
WS18P4SMA	WS18P4SMA-B	18	20.00	22.10	1	29.2	13.7	1
WS20P4SMA	WS20P4SMA-B	20	22.20	24.50	1	32.4	12.3	1
WS22P4SMA	WS22P4SMA-B	22	24.40	26.90	1	35.5	11.3	1
WS24P4SMA	WS24P4SMA-B	24	26.70	29.50	1	38.9	10.3	1
WS26P4SMA	WS26P4SMA-B	26	28.90	31.90	1	42.1	9.5	1
WS28P4SMA	WS28P4SMA-B	28	31.10	34.40	1	45.4	8.8	1
WS30P4SMA	WS30P4SMA-B	30	33.30	36.80	1	48.4	8.3	1
WS33P4SMA	WS33P4SMA-B	33	36.70	40.60	1	53.3	7.5	1
WS36P4SMA	WS36P4SMA-B	36	40.00	44.20	1	58.1	6.9	1
WS40P4SMA	WS40P4SMA-B	40	44.40	49.10	1	64.5	6.2	1
WS43P4SMA	WS43P4SMA-B	43	47.80	52.80	1	69.4	5.8	1
WS45P4SMA	WS45P4SMA-B	45	50.00	55.30	1	72.7	5.5	1

**Electrical Characteristics (Cont.)**

Part Number		Reverse Stand off Voltage $V_{RWM}$ (Volts)	Breakdown Voltage $V_{BR}(\text{Volts})@I_T$		Test Current $I_T$ (mA)	Maximum Clamping Voltage $V_C@I_{PP}$ (Volts)	Maximum Peak Pulse Current $I_{pp}$ (Amps)	Maximum Reverse Leakage $I_R@V_{RWM}$ ( $\mu$ A)
			MIN	MAX				
UNI-POLAR	BI-POLAR							
WS48P4SMA	WS48P4SMA-B	48	53.30	58.90	1	77.4	5.2	1
WS51P4SMA	WS51P4SMA-B	51	56.70	62.70	1	82.4	4.9	1
WS54P4SMA	WS54P4SMA-B	54	60.00	66.30	1	87.1	4.6	1
WS58P4SMA	WS58P4SMA-B	58	64.40	71.20	1	93.6	4.3	1
WS60P4SMA	WS60P4SMA-B	60	66.70	73.70	1	96.8	4.1	1
WS64P4SMA	WS64P4SMA-B	64	71.10	78.60	1	103	3.9	1
WS70P4SMA	WS70P4SMA-B	70	77.80	86.00	1	113	3.5	1
WS75P4SMA	WS75P4SMA-B	75	83.30	92.10	1	121	3.3	1
WS78P4SMA	WS78P4SMA-B	78	86.70	95.80	1	126	3.2	1
WS85P4SMA	WS85P4SMA-B	85	94.40	104	1	137	2.9	1
WS90P4SMA	WS90P4SMA-B	90	100	111	1	146	2.7	1
WS100P4SMA	WS100P4SMA-B	100	111	123	1	162	2.5	1
WS110P4SMA	WS110P4SMA-B	110	122	135	1	177	2.3	1
WS120P4SMA	WS120P4SMA-B	120	133	147	1	193	2.0	1
WS130P4SMA	WS130P4SMA-B	130	144	159	1	209	1.9	1
WS150P4SMA	WS150P4SMA-B	150	167	185	1	243	1.6	1
WS160P4SMA	WS160P4SMA-B	160	178	197	1	259	1.5	1
WS170P4SMA	WS170P4SMA-B	170	189	209	1	275	1.4	1
WS180P4SMA	WS180P4SMA-B	180	201	222	1	292	1.4	1
WS200P4SMA	WS200P4SMA-B	200	224	247	1	324	1.2	1
WS220P4SMA	WS220P4SMA-B	220	246	282	1	356	1.1	1
WS250P4SMA	WS250P4SMA-B	250	279	309	1	405	1.0	1
WS300P4SMA	WSP300SMA-B	300	335	371	1	486	0.8	1
WS350P4SMA	WS350P4SMA-B	350	391	432	1	567	0.7	1
WS400P4SMA	WS400P4SMA-B	400	447	492	1	648	0.6	1
WS440P4SMA	WS440P4SMA-B	440	492	543	1	713	0.6	1

### Typical Characteristics

Figure 1: Peak Pulse Power Rating Curve

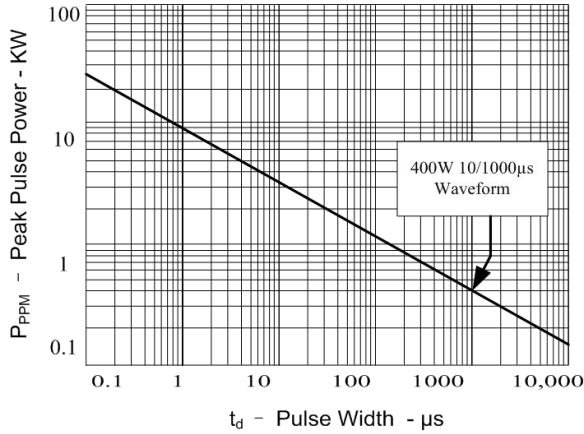

Figure 2: Pulse Derating Curve

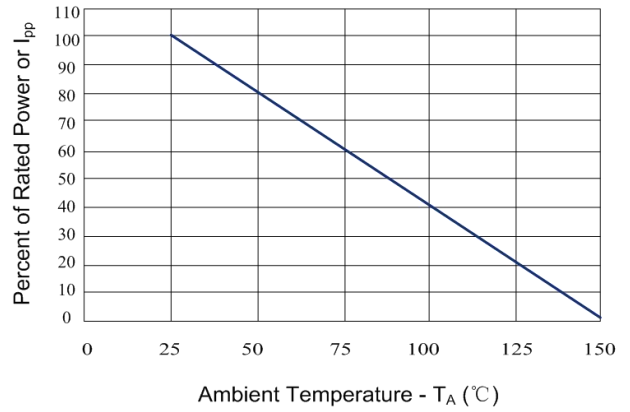

Figure 3: Pulse Waveform

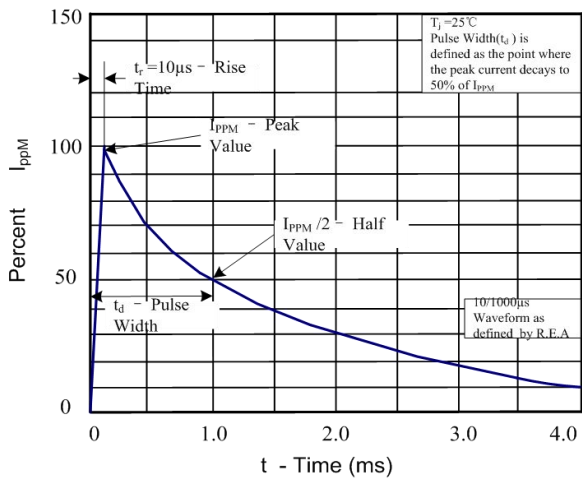

Figure 4: Typical Junction Capacitance

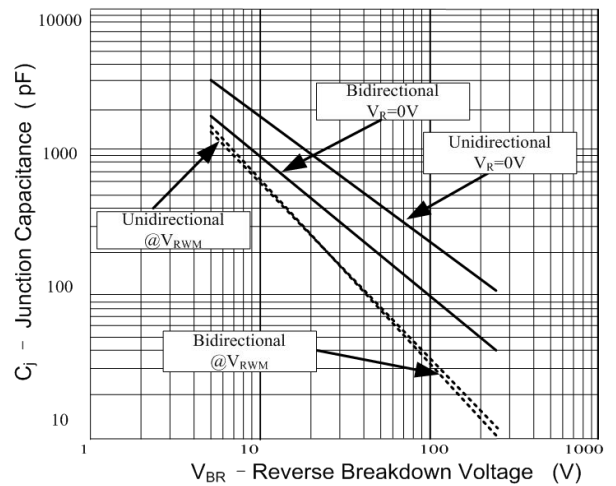

Figure 5: Steady State Power Dissipation Derating Curve

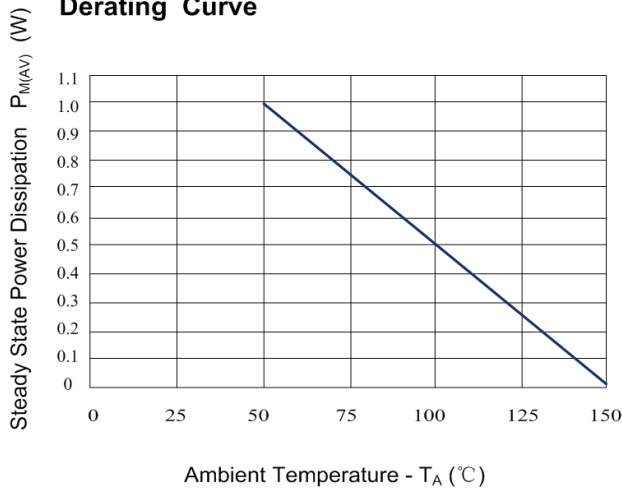
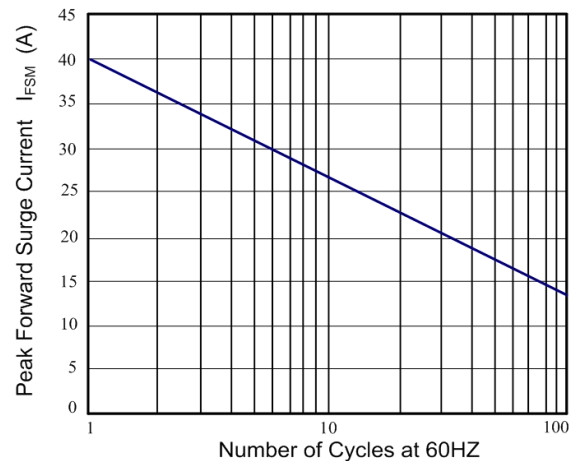
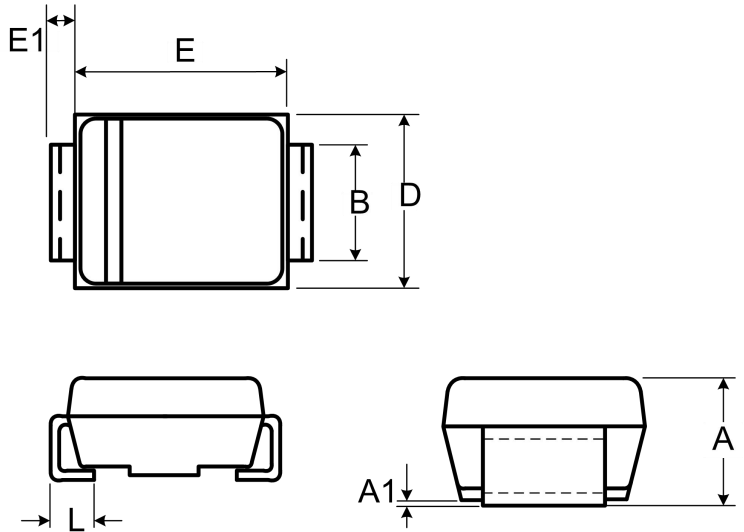

Figure 6: Maximum Non-Repetitive Forward Surge Current Only Unidirectional



Outline Drawing – SMAJ(DO-214AC)

Ref. (mm)	Millimeters	
	Min.	Max.
A	1.980	2.290
A1	-	0.203
B	1.250	1.650
E	3.990	4.500
E1	0.152	0.305
D	2.540	2.790
L	0.780	1.520



**CONTACT INFORMATION**

**SHANGHAI CHANGYUAN WAYON CIRCUIT PROTECTION CO., LTD.**

No.1001, Shiwan(7) Road, Pudong District, Shanghai, P.R.China.201202

Tel: 86-21-50310888 Fax: 86-21-50757680 Email: market@way-on.com

WAYON website: <http://www.way-on.com>

For additional information, please contact your local Sales Representative.



® and **WAY-ON** ® are registered trademarks of Wayon Corporation.